

RM SERIES SHELL SIZE 12 – 31mm CIRCULAR CONNECTORS

Introduction

RM Series are compact, circular connectors HIROSE has developed as the result of many years of research and proven experience to meet the most stringent demands of communication equipment as well as electronic equipment. RM Series is available in 5 shell sizes: 12, 15, 21, 24, and 31. There are also 16 kinds of contacts: 2, 3, 4, 5, 6, 7, 8, 10, 12, 15, 20, 31, 40, and 55 (contacts 2 and 4 are available in two types). And also available water proof type in special series. The lock mechanisms with thread coupling

type, bayonet sleeve type or quick detachable type are easy to use.

Various kinds of accessories are available.

RM Series are miniaturized in size, rugged and excellent in mechanical and electrical performance thus making it possible to meet the most stringent demands of users. Refer to the contact arrangements of RM series connectors on page 60~61.

Main materials (Note that the above may not apply depending on type.)

Part	Material	Finish
Shell	Brass and Zinc alloy	Nickel plated
Insulator	Synthetic resin	
Male contact	Copper alloy	Silver plated
Female contact	Copper alloy	Silver plated

Ordering Information

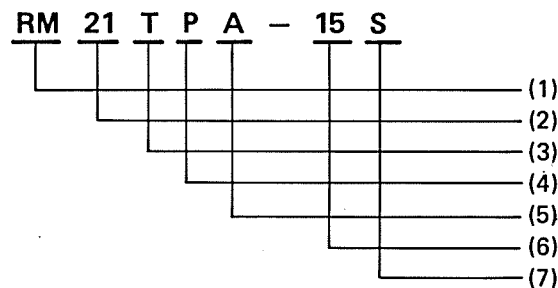

Product identification

- (1) RM: Round Miniature series name
 - (2) 21: The shell size is figured by outer diameter of fitting section of plug and available in 5 types, 12, 15, 21, 24, 31.
 - (3) T: Type of lock mechanism as follows;
 - T: Thread coupling type
 - B: Bayonet sleeve type
 - Q: Quick detachable type
 - (4) P: Type of connector
 - P: Plug
 - R: Receptacle:
 - J: Jack
 - WP: Waterproof
 - WR: Waterproof receptacle
 - P-CP*: Cord clamp for plug
- (* is shown applicable diameter of cable)

- R-C: Cap of receptacle
 - R-F: Square flange for receptacle
 - P-B: Cord bushing
 - (5) A: Shell model change mark
 - Each time the shell undergoes a change in enclosure or the like, it is marked as A, B, D, E.
 - Do not use the letter for C, J, P, R avoiding confusion.
 - (6) 15: Number of pins
 - (7) S: Shape of contact
 - P: Pin
 - S: Socket
- However, connecting method of contact or type shall be classified adding with alphabetical letter.

Standard RM Series

Standard RM series are more compact and higher in performance than our former models. Mechanically stable thanks to its rigid and simple construction. Used widely for all types of equipment, although no special measures are taken for resistance to harsh conditions such as dustproof or waterproof design.

RM12B Connectors

(Bayonet sleeve type)

RM12B connectors (bayonet sleeve type) are provided with a bayonet sleeve locking mechanism, the most compact in the series.

Plug

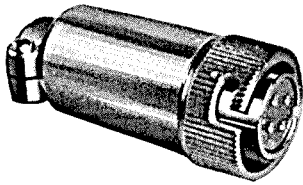

RM12BPG-4S(07)

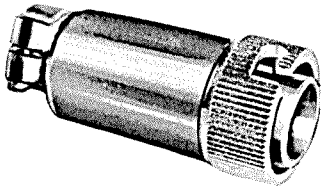

RM12BPG-4PH

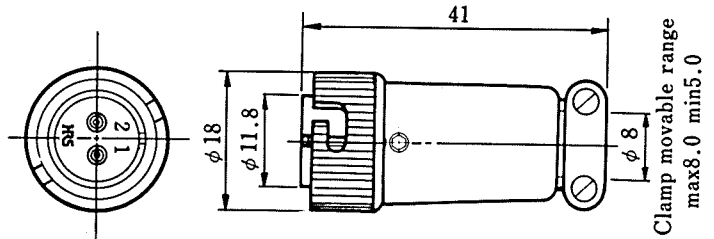

(An example in shape)

HRS No.	Part No.	No. of pins	HRS No.	Part No.	No. of pins
109-0567-0-07	RM12BPG-2S(07)	2	109-0811-9	RM12BPG-2PH	2
109-0568-2-07	RM12BPG-3S(07)	3	109-0812-1	RM12BPG-3PH	3
109-0569-5-07	RM12BPG-4S(07)	4	109-0813-4	RM12BPG-4PH	4
109-0570-4-07	RM12BPG-5S(07)	5	109-0814-7	RM12BPG-5PH	5
109-0571-7-07	RM12BPG-6S(07)	6	109-0815-0	RM12BPG-6PH	6
109-0616-3-07	RM12BPG-7S(07)	7	109-0816-2	RM12BPG-7PH	7

Receptacle

Receptacle(Jam Nut to be fastened)

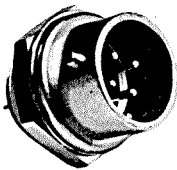

RM12BRD-4PH

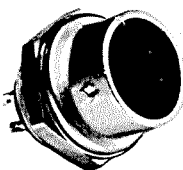

RM12BRD-4S

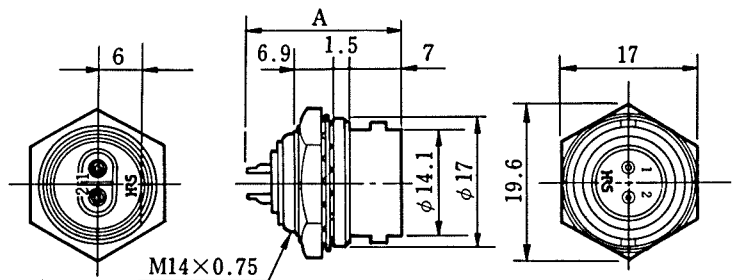

(An example in shape)

HRS No.	Part No.	No. of pins	A	HRS No.	Part No.	No. of pins	A
109-0823-8	RM12BRD-2PH	2	20.5	109-0609-8	RM12BRD-2S	2	21.6
109-0824-0	RM12BRD-3PH	3	20.5	109-0610-7	RM12BRD-3S	3	21.6
109-0825-3	RM12BRD-4PH	4	20.5	109-0611-0	RM12BRD-4S	4	21.6
109-0826-6	RM12BRD-5PH	5	20.5	109-0612-2	RM12BRD-5S	5	21.6
109-0827-9	RM12BRD-6PH	6	20.5	109-0613-5	RM12BRD-6S	6	21.6
109-0828-1	RM12BRD-7PH	7	20.5	109-0619-1	RM12BRD-7S	7	21.6

Remark: For mounting holes, see page 60.

Receptacle

Receptacle (square flange) single method

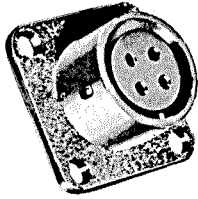

RM12BRB-4S

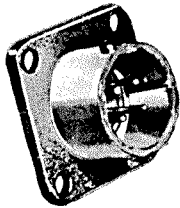
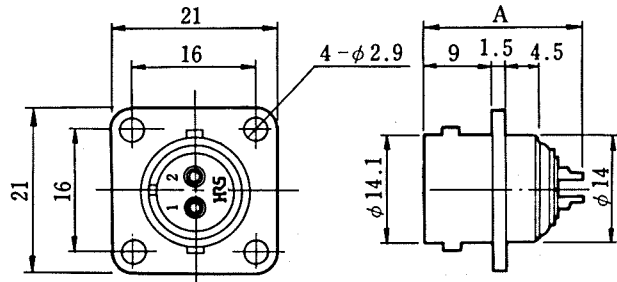

RM12BRB-4PH

(An example in shape)

HRS No.	Part No.	No. of pins	A	HRS No.	Part No.	No. of pins	A
109-0577-3	RM12BRB-2S	2	21.6	109-0817-5	RM12BRB-2PH	2	20.5
109-0578-6	RM12BRB-3S	3	21.6	109-0818-8	RM12BRB-3PH	3	20.5
109-0579-9	RM12BRB-4S	4	21.6	109-0819-0	RM12BRB-4PH	4	20.5
109-0580-8	RM12BRB-5S	5	21.6	109-0820-0	RM12BRB-5PH	5	20.5
109-0581-0	RM12BRB-6S	6	21.6	109-0821-2	RM12BRB-6PH	6	20.5
109-0615-0	RM12BRB-7S	7	21.6	109-0822-5	RM12BRB-7PH	7	20.5

- Remarks: 1. For mounting holes, see page 60.
 2. Note that the RM12BRB differs in mounting dimensions from the RM12BR-F.

Jack

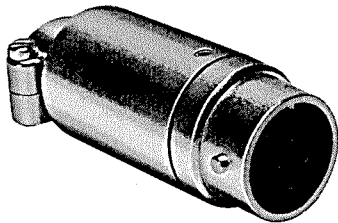

RM12BJB-2S(07)

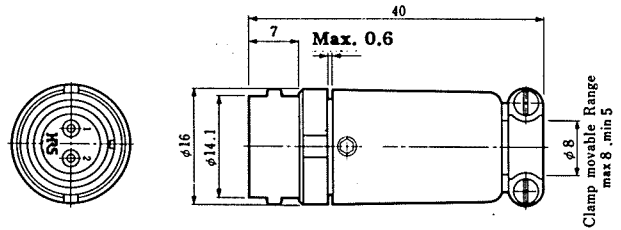

(An example in shape)

HRS No.	Part No.	No. of pins	HRS No.	Part No.	No. of pins
109-0638-6-07	RM12BJB-2S(07)	2	109-0829-4	RM12BJB-2PH	2
109-0639-9-07	RM12BJB-3S(07)	3	109-0830-3	RM12BJB-3PH	3
109-0640-8-07	RM12BJB-4S(07)	4	109-0831-6	RM12BJB-4PH	4
109-0641-0-07	RM12BJB-5S(07)	5	109-0832-9	RM12BJB-5PH	5
109-0642-3-07	RM12BJB-6S(07)	6	109-0833-1	RM12BJB-6PH	6
109-0643-6-07	RM12BJB-7S(07)	7	109-0834-4	RM12BJB-7PH	7

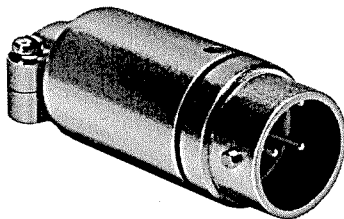

RM12BJB-2PH

Model RM15Q Connectors

(Quick insertion/extraction system)

The model RM15Q connectors have a quick insertion/extraction locking mechanism. Developed by HIROSE, this mechanism allows quicker operation than the locking mechanism of a thread coupling or bayonet coupling.

Plug

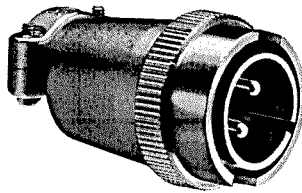

RM15QPS-2PA

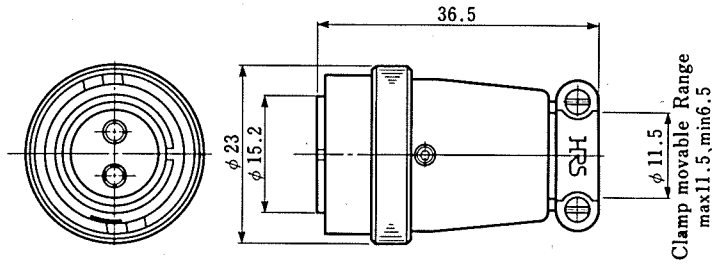

(An example in shape)

HRS No.	Part No.	No. of pins
109-0839-8	RM15QPS-2SA	2
109-0840-7	RM15QPS-4SA	4
109-0852-6	RM15QPS-8S	8
109-0853-9	RM15QPS-10S	10
109-0981-9	RM15QPS-12S	12

HRS No.	Part No.	No. of pins
109-0896-1	RM15QPS-2PA	2
109-0897-4	RM15QPS-4PA	4
109-0850-0	RM15QPS-8PH	8
109-0851-3	RM15QPS-10PH	10
109-0980-6	RM15QPS-12PH	12

Receptacle (Jam Nut to be fastened)

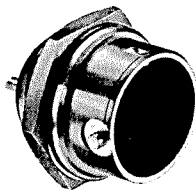

RM15QRD-2SA

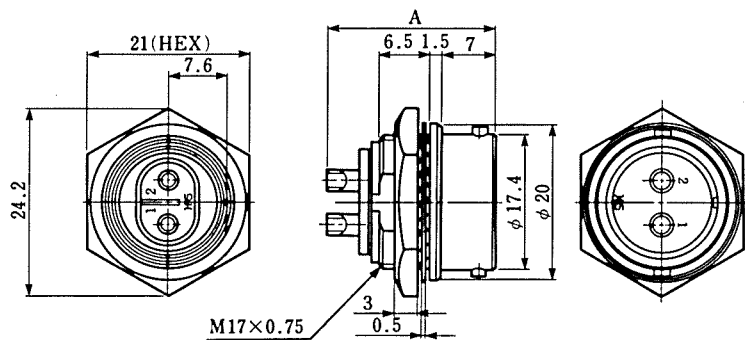

(An example in shape)

HRS No.	Part No.	No. of pins	A
109-0880-1	RM15QRD-2PA	2	21
109-0881-4	RM15QRD-4PA	4	21
109-0854-1	RM15QRD-8PH	8	20.6
109-0855-4	RM15QRD-10PH	10	20.6
109-0982-1	RM15QRD-12PH	12	20.6

HRS No.	Part No.	No. of pins	A
109-0841-0	RM15QRD-2SA	2	21.7
109-0842-2	RM15QRD-4SA	4	21.7
109-0864-5	RM15QRD-8S	8	21.6
109-0779-8	RM15QRD-10S	10	21.6
109-0983-4	RM15QRD-12S	12	21.6

Remark: For mounting holes, see page 60.

RM()T Connectors

(Thread coupling)

Plug

The RM[]T connectors have a screw coupling locking mechanism. Four models of the connectors with shell sizes of 15, 21, 24, and 31 have this locking mechanism. A connector of shell size 15 uses threads of 1 mm pitch. Connectors of shell size 21 and larger use trapezoidal threads for quick operation.

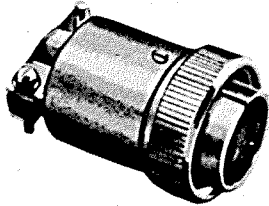

RM15TP-2SA

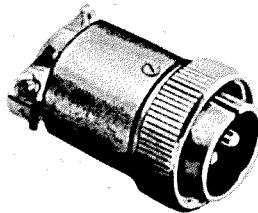

RM15TP-2PA

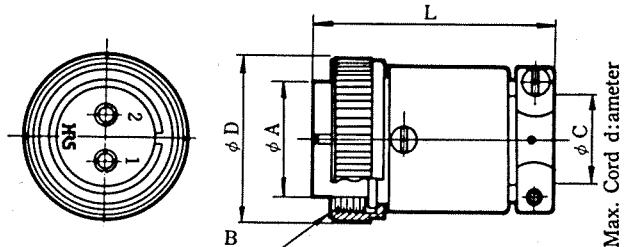

(An example in shape)

HRS No.	Part No.	No. of pins	phi A	B	phi C	phi C	L
109-0845-0	RM15TP-2SA	2	15.2	M19x1	11.5	21.5	34
109-0898-7	RM15TP-2PA	2	15.2	M19x1	11.5	21.5	34
109-0846-3	RM15TP-4SA	4	15.2	M19x1	11.5	21.5	34
109-0899-0	RM15TP-4PA	4	15.2	M19x1	11.5	21.5	34
109-0053-2	RM15TP-8S	8	15.2	M19x1	11.5	21.5	34
109-0856-7	RM15TP-8PH	8	15.2	M19x1	11.5	21.5	34
109-0055-8	RM15TP-10S	10	15.2	M19x1	11.5	21.5	34
109-0857-0	RM15TP-10PH	10	15.2	M19x1	11.5	21.5	34
109-0321-0	RM21TP-15S	15	21	TM25x2	15	28	37
109-0323-5	RM21TP-15P	15	21	TM25x2	15	28	37
109-0322-2	RM21TP-20S	20	21	TM25x2	15	28	37
109-0324-8	RM21TP-20P	20	21	TM25x2	15	28	37
109-0481-6	RM24TP-31S	31	24.3	TM29x2	19	32	41
109-0482-9	RM24TP-31P	31	24.3	TM29x2	19	32	41
109-0361-4	RM31TP-40S	40	30.8	TM35x2	26	40	47
109-0363-0	RM31TP-40P	40	30.8	TM35x2	26	40	47
109-0362-7	RM31TP-55S	55	30.8	TM35x2	26	40	47
109-0364-2	RM31TP-55P	55	30.8	TM35x2	26	40	47

Remark: TM25X2 is shown trapezoidal thread of 30°.

Receptacle (Jam Nut to be fastened)

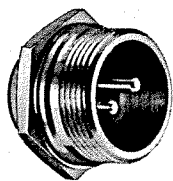

RM15TRH-2PA

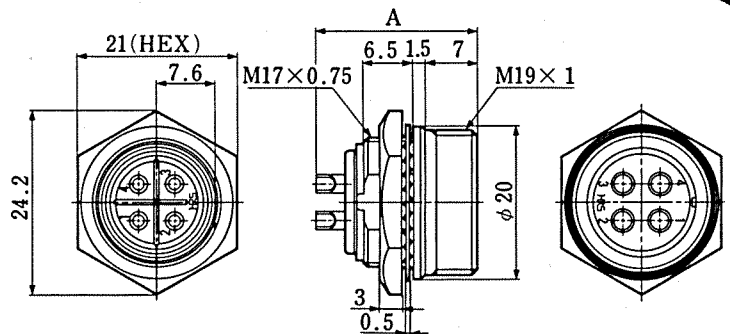

(An example in shape)

HRS No.	Part No.	No. of pins	A
109-0886-8	RM15TRH-2PA	2	21
109-0847-6	RM15TRH-2SA	2	21.7
109-0887-0	RM15TRH-4PA	4	21
109-0848-9	RM15TRH-4SA	4	21.7
109-0858-2	RM15TRH-8PH	8	20.6
109-0868-6	RM15TRH-8S	8	21.6
109-0859-5	RM15TRH-10PH	10	20.6
109-0869-8	RM15TRH-10S	10	21.6

Remark: For mounting holes, see page 60.

Receptacle

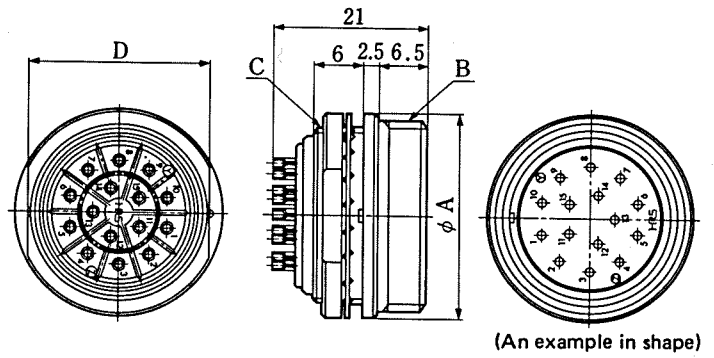
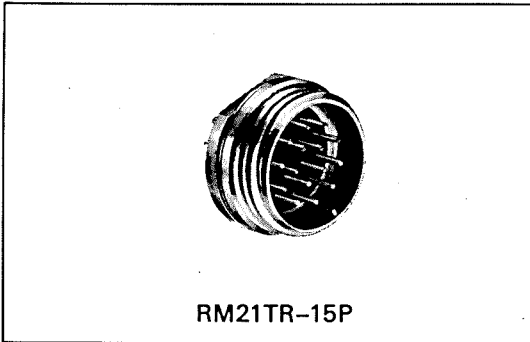

HRS No.	Part No.	No. of pins	ϕA	B	C	D
109-0325-0	RM21TR-15P	15	27	TM25x2	M22x0.75	23.5
109-0327-6	RM21TR-15S	15	27	TM25x2	M22x0.75	23.5
109-0326-3	RM21TR-20P	20	27	TM25x2	M22x0.75	23.5
109-0328-9	RM21TR-20S	20	27	TM25x2	M22x0.75	23.5
109-0483-1	RM24TR-31P	31	31	TM29x2	M26x0.75	28
109-0484-4	RM24TR-31S	31	31	TM29x2	M26x0.75	28
109-0365-5	RM31TR-40P	40	37	TM35x2	M32x0.75	34
109-0367-0	RM31TR-40S	40	37	TM35x2	M32x0.75	34
109-0366-8	RM31TR-55P	55	37	TM35x2	M32x0.75	34
109-0368-3	RM31TR-55S	55	37	TM35x2	M32x0.75	34

Remarks: 1. TM25X2 is shown trapezoidal thread of 30°.
2. For mounting holes, see page 60.

Tool

Hexagon Wrench Screwdriver

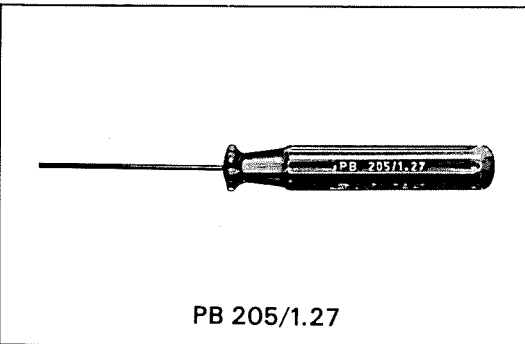

HRS No.	Part No.	Remark
150-0066-3	PB205/1.27	

RM15T(D Type) connectors

The RM15T (model D) connectors are designed for high grade of commercial applications such as VTR. These connectors boast a highly refined design. Since the model D uses locking threads of 30° trapezoidal threads, it is incompatible with the RM15T connectors.

Plug

(Solder Type)

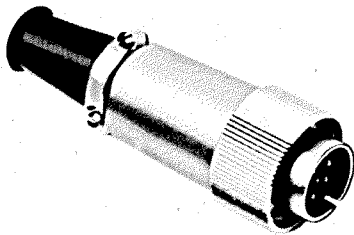

RM15TPD-10P

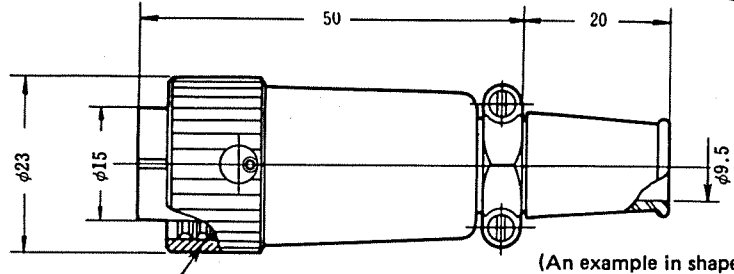

(An example in shape)

HRS No.	Part No.	No. of pins
109-0686-9	RM15TPD-10S	10
109-0601-6	RM15TPD-10P	10
109-0660-5	RM15TPD-12P	12
109-0661-8	RM15TPD-12S	12

Jack

(Solder Type)

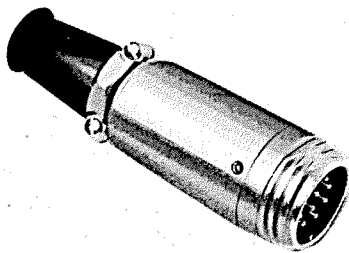

RM15TJD-10P

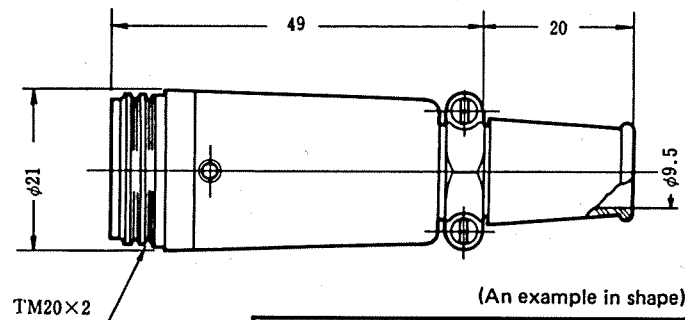

(An example in shape)

HRS No.	Part No.	No. of pins
109-0706-4	RM15TJD-10P	10
109-0603-1	RM15TJD-10S	10
109-0665-9	RM15TJD-12S	12

Receptacle

(Solder Type)

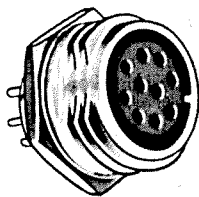

RM15TRD-10S

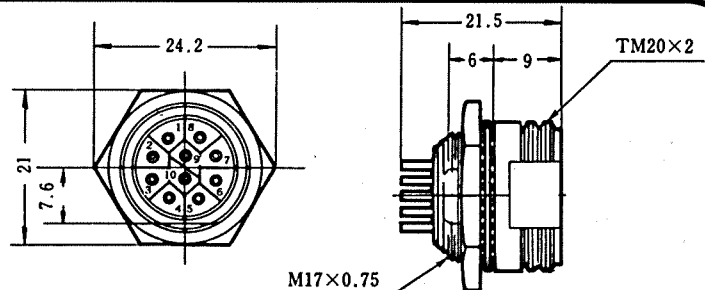

(An example in shape)

HRS No.	Part No.	No. of pins
109-0687-1	RM15TRD-10P	10
109-0602-9	RM15TRD-10S	10
109-0662-0	RM15TRD-12P	12
109-0663-3	RM15TRD-12S	12

Remark: For mounting holes, see page 60.

Plug

(Crimp Type)

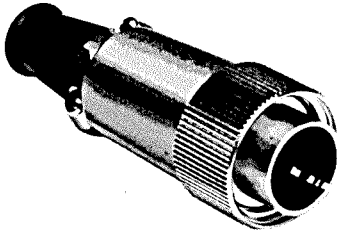

RM15TPD-10PC

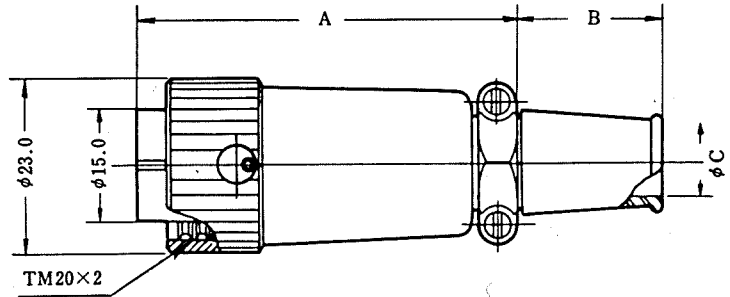

(An example in shape)

HRS No.	Part No.	No. of pins	A	B	φC
109-0677-8	RM15TPD-10PC	10	50	20	9.5
109-0712-7	RM15TPN-10PC	10	40	15	8

Receptacle

(Crimp Type)

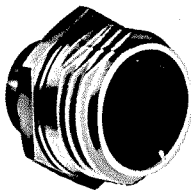

RM15TRD-10SC

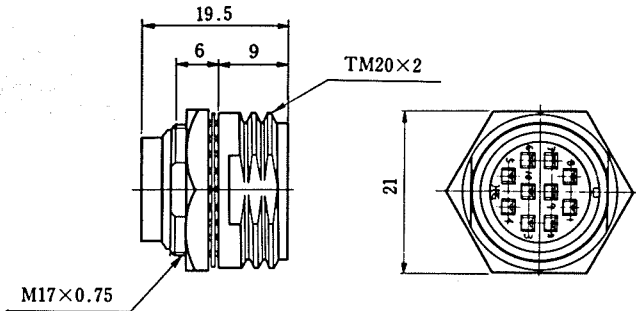

HRS No.	Part No.	No. of pins
109-0676-5	RM15TRD-10SC	10

Remark: For mounting holes, see page 60.

Receptacle

(Dip Type)

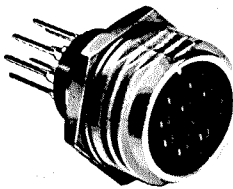

RM15TRD-10SB

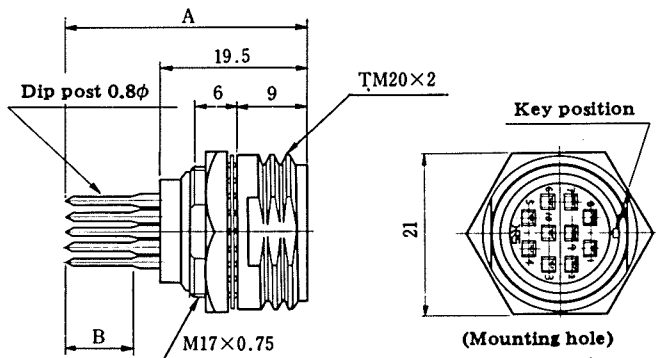

(An example in shape)

HRS No.	Part No.	No. of pins	A	B
109-0710-1	RM15TRD-10SB	10	32.3	8.3
109-0722-0	RM15TRD-10SD	10	27.8	3.8

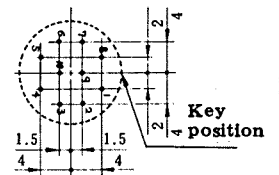

Remark: For mounting holes, see page 60.

■ Contact

Pin contact

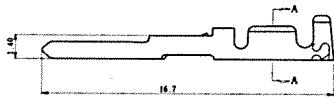

Fig-1

SectionA-A

Type	HRS No.	Part No.	B	C	Applicable wire
Loose contact	109-0668-7	RM-PC-112	1.6	2.0	AWG#20~#24
	109-0672-4	RM-PC-122	1.45	1.5	AWG#24~#28
Chain contact	109-0670-9	RM-PC-212	1.6	2.0	AWG#20~#24
	109-0674-0	RM-PC-222	1.45	1.5	AWG#24~#28

Socket contact

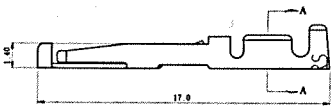

Fig-2

SectionA-A

Type	HRS No.	Part No.	B	C	Applicable wire
Loose contact	109-0669-0	RM-SC-112	1.6	2.0	AWG#20~#24
	109-0673-7	RM-SC-122	1.45	1.5	AWG#24~#28
Chain contact	109-0671-1	RM-SC-212	1.6	2.0	AWG#20~#24
	109-0675-2	RM-SC-222	1.45	1.5	AWG#24~#28

Note: Loose-piece pins are available in pack.

Each pack contains 100 pieces.

Reel pins are available, one reel contains 8,000 pieces.

◆ Tools

Type	Item	HRS No.	Part No.	Applicable terminal	Applicable wire
Manual	Manual crimping tool	150-0006-1	RM-TC-11	RM-PC-112	AWG#20~#24
				RM-SC-112	
	150-0007-4	RM-TC-12	RM-PC-122	AWG#24~#28	
			RM-SC-122		
Automatic	Automatic crimping machine body	901-0005-4	CM-105	—	—
	Applicator	901-2017-4	AP105-RM-1	RM-PC-212	AWG#20~#24
				RM-SC-212	
		901-2018-7	AP105-RM-2	RM-PC-222	AWG#24~#28
				RM-SC-222	
Extraction	150-0008-7	RM-TP	—	—	

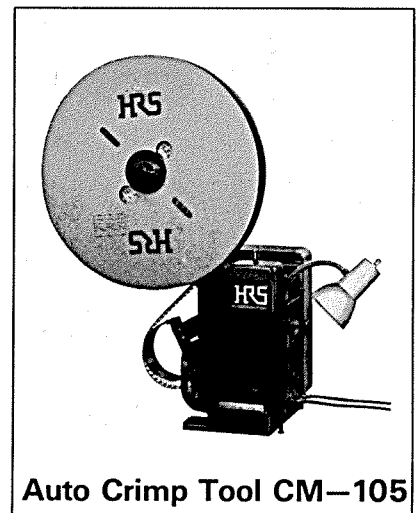

Auto Crimp Tool CM-105



Hand Crimp Tool



Extraction Tool

Waterproof RM Series

The Waterproof RM Series has been developed by redesigning the standard RM Series, but maintaining the same electrical specifications as the standard RM Series.

Model RM12WB Connectors

The RM12B is designed to be watertight for 48 hours at 0.5 M under water, and the RM15T or above is designed to be watertight for 48 hours at 1.0 M under water.

Plug

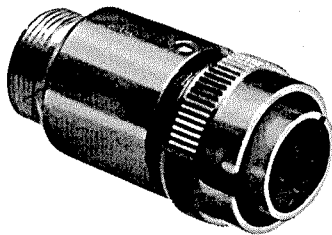

RM12WBP-4S

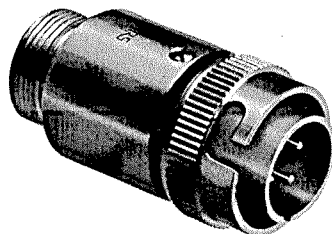

RM12WBP-4P

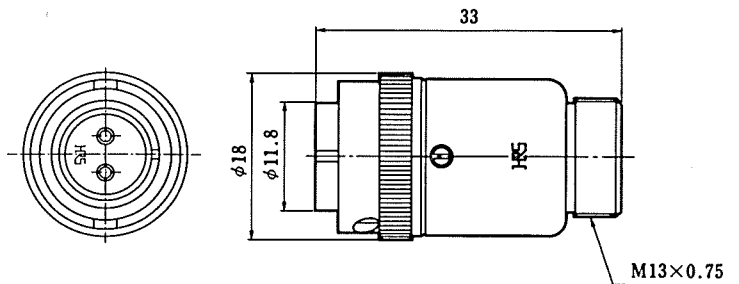

(An example in shape)

HRS No.	Part No.	No. of pins	HRS No.	Part No.	No. of pins
109-1141-3	RM12WBP-2S	2	109-1146-7	RM12WBP-2P	2
109-1142-6	RM12WBP-3S	3	109-1147-0	RM12WBP-3P	3
109-1143-9	RM12WBP-4S	4	109-1148-2	RM12WBP-4P	4
109-1144-1	RM12WBP-5S	5	109-1149-5	RM12WBP-5P	5
109-1145-4	RM12WBP-6S	6	109-1150-4	RM12WBP-6P	6

Note 1: Be sure to use plugs in combination with code clamps.

Receptacle

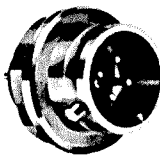

RM12WBR-4P

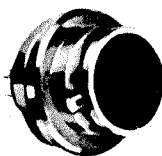

RM12WBR-4S

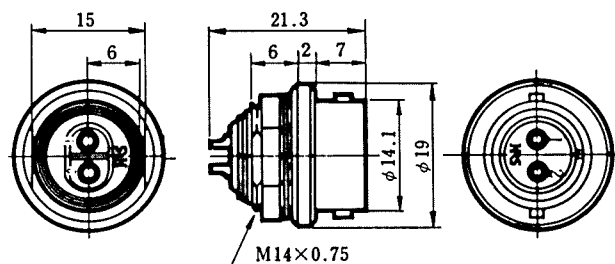

(An example in shape)

HRS No.	Part No.	No. of pins	HRS No.	Part No.	No. of pins
109-1021-1	RM12WBR-2P	2	109-1026-5	RM12WBR-2S	2
109-1022-4	RM12WBR-3P	3	109-1027-8	RM12WBR-3S	3
109-1023-7	RM12WBR-4P	4	109-1028-0	RM12WBR-4S	4
109-1024-0	RM12WBR-5P	5	109-1029-3	RM12WBR-5S	5
109-1025-2	RM12WBR-6P	6	109-1030-2	RM12WBR-6S	6

Remark: For mounting holes, see page 60.

Cord Clamp

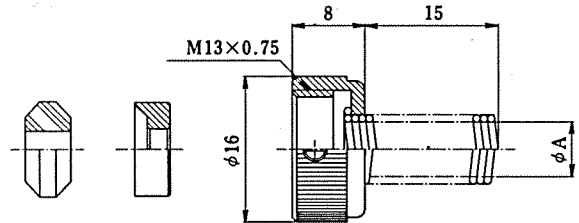
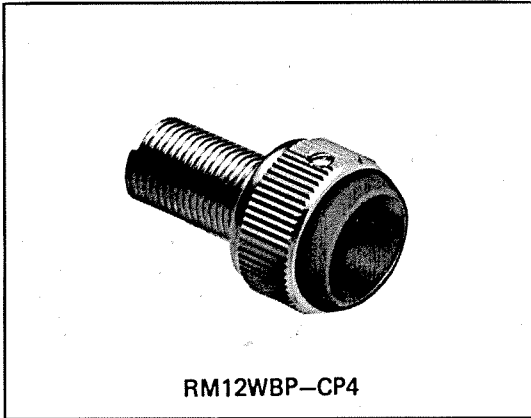

(An example in shape)

HRS No.	Part No.	φA	Cable dia.
109-1151-7	RM12WBP-CP4	5.5	φ4
109-1152-0	RM12WBP-CP5	5.5	φ5
109-1153-2	RM12WBP-CP6	7.5	φ6
109-1154-5	RM12WBP-CP7	7.5	φ7

Note: Carefully choose the applicable cable because clamping force and waterproofness differ according to the type.

RM()WT type connector

Plug

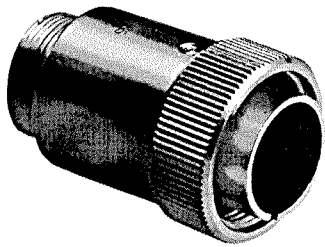

RM15WTP-10S

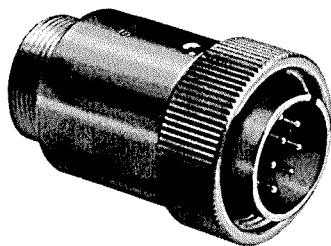

RM15WTP-10P

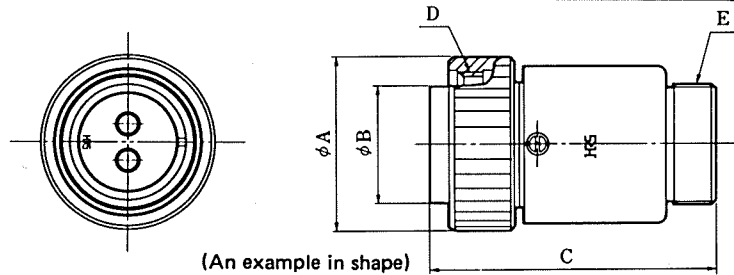

HRS No.	Part No.	No. of pin	φ A	φ B	C	D	E
109-1241-8	RM15WTP-2S	2	23	15.2	36.8	M19×1	M16×0.75
109-1242-0	RM15WTP-4S	4	23	15.2	36.8	M19×1	M16×0.75
109-1243-3	RM15WTP-8S	8	23	15.2	36.8	M19×1	M16×0.75
109-1244-6	RM15WTP-10S	10	23	15.2	36.8	M19×1	M16×0.75
109-1262-8	RM15WTP-12S	12	23	15.2	36.8	M19×1	M16×0.75
109-1245-9	RM15WTP-2P	2	23	15.2	36.8	M19×1	M16×0.75
109-1246-1	RM15WTP-4P	4	23	15.2	36.8	M19×1	M16×0.75
109-1247-4	RM15WTP-8P	8	23	15.2	36.8	M19×1	M16×0.75
109-1248-7	RM15WTP-10P	10	23	15.2	36.8	M19×1	M16×0.75
109-1257-8	RM15WTP-12P	12	23	15.2	36.8	M19×1	M16×0.75
109-1401-2	RM21WTP-15S	15	32	21	37.5	TM25×2	M20×0.75
109-1402-5	RM21WTP-20S	20	32	21	37.5	TM25×2	M20×0.75
109-1403-8	RM21WTP-15P	15	32	21	37.5	TM25×2	M20×0.75
109-1404-0	RM21WTP-20P	20	32	21	37.5	TM25×2	M20×0.75
109-1491-5	RM24WTP-31S	31	36	24.3	44	TM29×2	M24×0.75
109-1492-8	RM24WTP-31P	31	36	24.3	44	TM29×2	M24×0.75
109-1571-2	RM31WTP-40S	40	42	30.8	52	TM35×2	M28×0.75
109-1572-5	RM31WTP-55S	55	42	30.8	52	TM35×2	M28×0.75
109-1573-8	RM31WTP-40P	40	42	30.8	52	TM35×2	M28×0.75
109-1574-0	RM31WTP-55P	55	42	30.8	52	TM35×2	M28×0.75

Note 1) Be sure to use plugs in combination with code clamps.

Receptacle

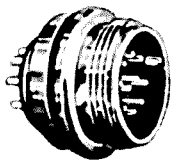

RM15WTR-10P

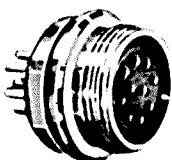

RM15WTR-10S

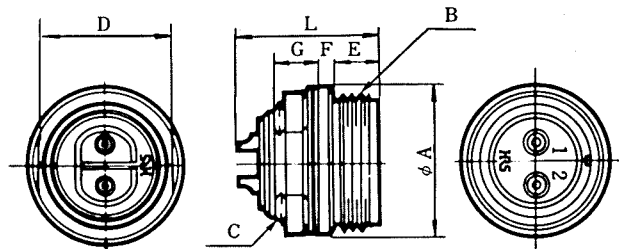

HRS No.	Part No.	No. of pin	φ A	B	C	D	E	F	G	L
109-1309-0	RM15WTR-2P	2	22	M19×1	M17×0.75	18	7	2	6	21.0
109-1316-5	RM15WTR-2S	2	22	M19×1	M17×0.75	18	7	2	6	21.5
109-1311-1	RM15WTR-4P	4	22	M19×1	M17×0.75	18	7	2	6	21.0
109-1318-0	RM15WTR-4S	4	22	M19×1	M17×0.75	18	7	2	6	21.5
109-1313-7	RM15WTR-8P	8	22	M19×1	M17×0.75	18	7	2	6	20.5
109-1320-2	RM15WTR-8S	8	22	M19×1	M17×0.75	18	7	2	6	21.5
109-1315-2	RM15WTR-10P	10	22	M19×1	M17×0.75	18	7	2	6	20.5
109-1322-8	RM15WTR-10S	10	22	M19×1	M17×0.75	18	7	2	6	21.5
109-1261-5	RM15WTR-12P	12	22	M19×1	M17×0.75	18	7	2	6	21.0
109-1260-2	RM15WTR-12S	12	22	M19×1	M17×0.75	18	7	2	6	21.5
109-1445-8	RM21WTR-15P	15	31	TM25×2	M22×0.75	23.5	6.5	2.5	6	21.0
109-1447-3	RM21WTR-15S	15	31	TM25×2	M22×0.75	23.5	6.5	2.5	6	21.0
109-1446-0	RM21WTR-20P	20	31	TM25×2	M22×0.75	23.5	6.5	2.5	6	21.0
109-1448-6	RM21WTR-20S	20	31	TM25×2	M22×0.75	23.5	6.5	2.5	6	21.0
109-1483-7	RM24WTR-31P	31	35	TM29×2	M26×0.75	28	6.5	2.5	6	21.0
109-1484-0	RM24WTR-31S	31	35	TM29×2	M26×0.75	28	6.5	2.5	6	21.0
109-1525-5	RM31WTR-40P	40	41	TM35×2	M32×0.75	34	6.5	2.5	6	21.5
109-1527-0	RM31WTR-40S	40	41	TM35×2	M32×0.75	34	6.5	2.5	6	21.5
109-1526-8	RM31WTR-55P	55	41	TM35×2	M32×0.75	34	6.5	2.5	6	21.5
109-1528-3	RM31WTR-55S	55	41	TM35×2	M32×0.75	34	6.5	2.5	6	21.5

Remark: For the mounting holes, see page 60.

Cord Clamp

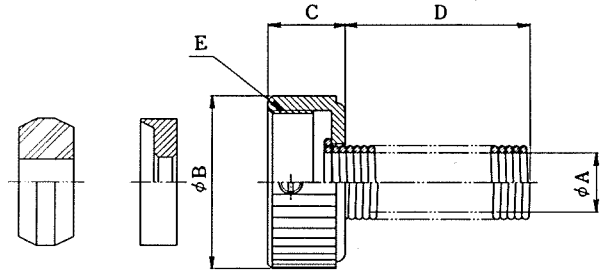
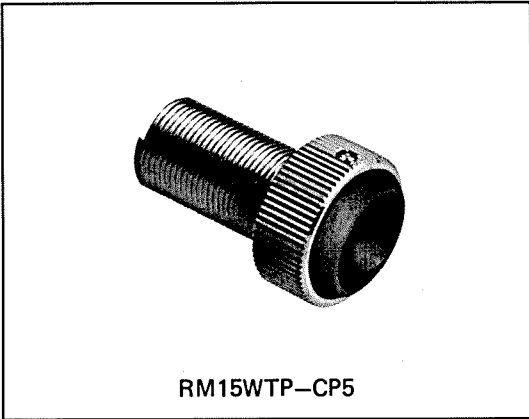

(An example in shape)

HRS No.	Part No.	ϕA	ϕB	C	D	E	Cable dia.
109-1249-0	RM15WTP-CP5	6.5	19	8.5	20	M16x0.75	$\phi 5$
109-1250-9	RM15WTP-CP6	6.5	19	8.5	20	M16x0.75	$\phi 6$
109-1251-1	RM15WTP-CP7	8	19	8.5	20	M16x0.75	$\phi 7$
109-1252-4	RM15WTP-CP8	10.5	19	8.5	20	M16x0.75	$\phi 8$
109-1253-7	RM15WTP-CP9	10.5	19	8.5	20	M16x0.75	$\phi 9$
109-1254-0	RM15WTP-CP10	10.5	19	8.5	20	M16x0.75	$\phi 10$
109-1405-3	RM21WTP-CP8	10.3	23	7.5	30	M20x0.75	$\phi 8$
109-1406-6	RM21WTP-CP10	10.3	23	7.5	30	M20x0.75	$\phi 10$
109-1407-9	RM21WTP-CP12	12.3	23	7.5	30	M20x0.75	$\phi 12$
109-1493-0	RM24WTP-CP10	12.5	27	8	30	M24x0.75	$\phi 10$
109-1494-3	RM24WTP-CP12	12.5	27	8	30	M24x0.75	$\phi 12$
109-1495-6	RM24WTP-CP14	16.5	27	8	30	M24x0.75	$\phi 14$
109-1496-9	RM24WTP-CP16	16.5	27	8	30	M24x0.75	$\phi 16$
109-1575-3	RM31WTP-CP10	14.5	31	12	30	M28x0.75	$\phi 10$
109-1576-6	RM31WTP-CP12	14.5	31	12	30	M28x0.75	$\phi 12$
109-1579-4	RM31WTP-CP14	14.5	31	12	30	M28x0.75	$\phi 14$
109-1577-9	RM31WTP-CP16	18.5	31	12	30	M28x0.75	$\phi 16$
109-1578-1	RM31WTP-CP18	18.5	31	12	30	M28x0.75	$\phi 18$

Note: Carefully chose the applicable cable because clamping force and waterproofness differ according to the type.

RM Series accessories

The RM series have accessories such as a cap, cord busing, and square flange designed for different applications.

Caps

The cap protects the mating surface and threads of the connector and prevents dust and water from entering. The cap is designed for both the standards and waterproof connector.

Plug cap

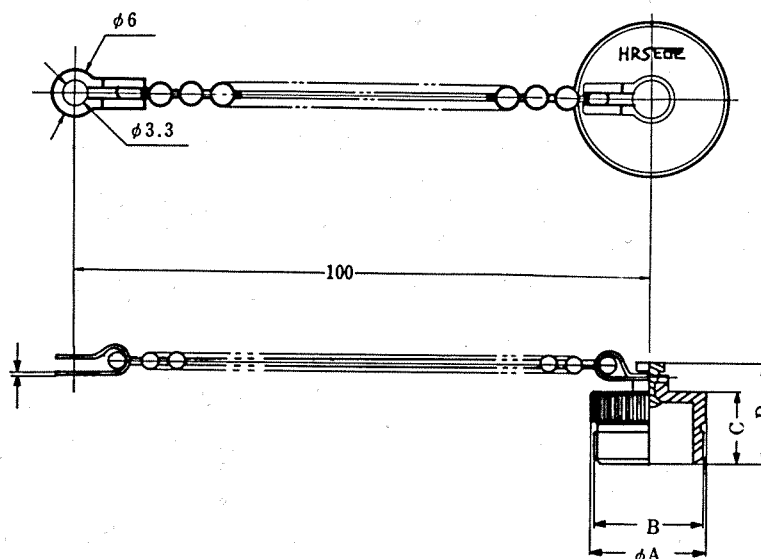
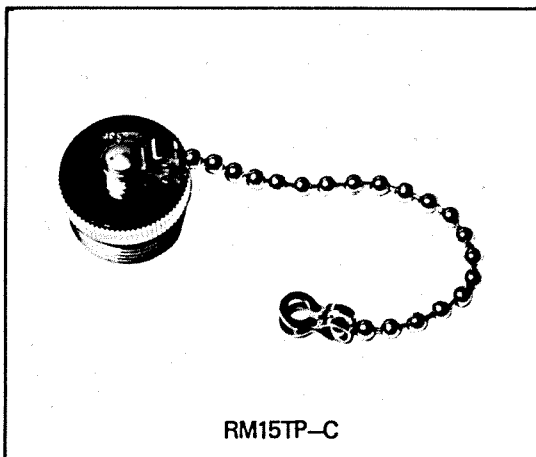

(An example in shape)

HRS No.	Part No.	ϕA	B	C	D
109-0079-6	RM15TP-C	21.5	M19x1	12	16.5
109-0353-6	RM21TP-C	28	TM25x2	17.5	22

Receptacle cap

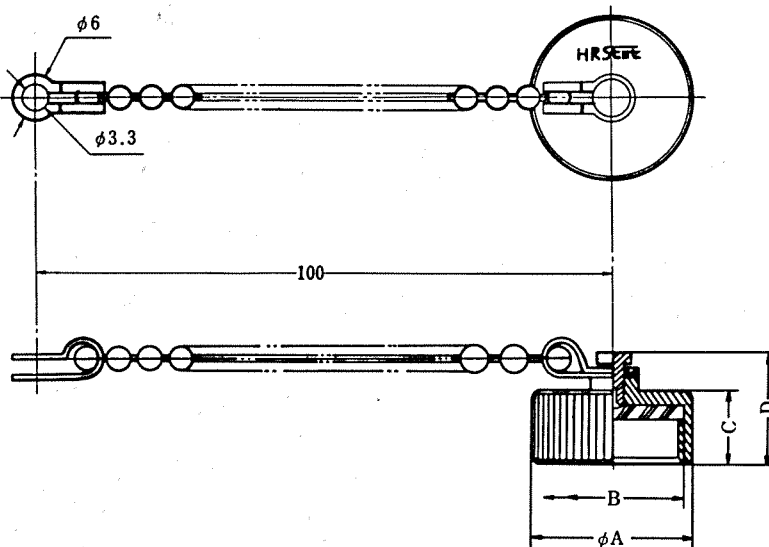
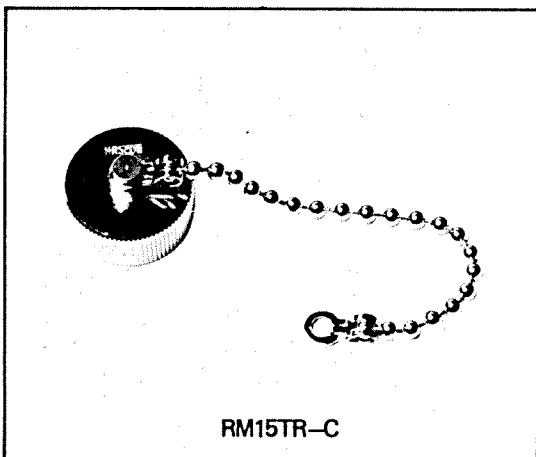

(An example in shape)

HRS No.	Part No.	ϕA	B	C	D
109-0080-5	RM15TR-C	21.5	M19x1	9	13.5
109-0354-9	RM21TR-C	28	TM25x2	8	12.5
109-0492-2	RM24TR-C	32	TM29x2	8.5	13
109-0394-3	RM31TR-C	38	TM35x2	8.5	13

Square Flange

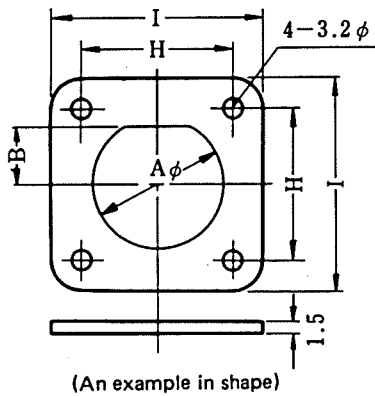

Square Flange is used with Bayonet Lock type receptacle.

HRS No.	Part No.	ϕA	B	H	I
109-0154-0-01	RM12BR-F(01)	14.1	6	18	26
109-0319-8-01	RM15TR-F(01)	17.1	7.6	20.6	28

Cord Bushing

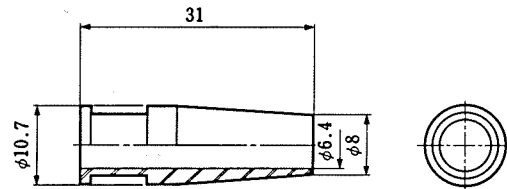

HRS No.	Part No.	Remark.
109-0776-0	RM12BPG-B	

How to use the RM15Q Connectors

(Quick insertion and extraction system)

1. Insertion

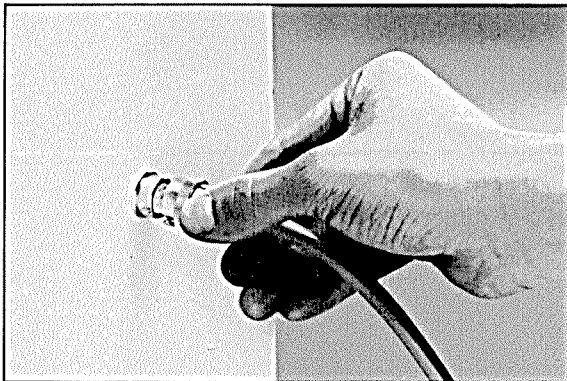

Holding the plug body, match the key with the keyway on the receptacle and push straight in. Turn plug 30° to the right, coupling is completed.

2. Extraction

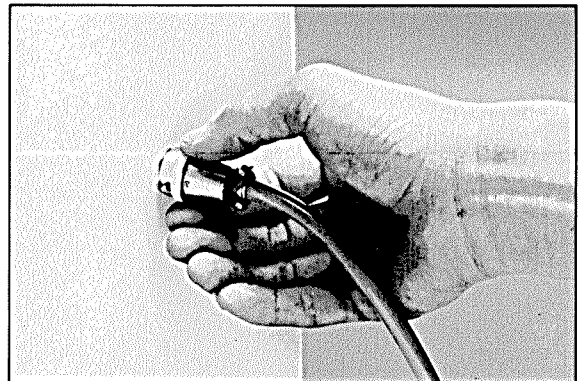

Holding plug sleeve, twist it 30 degrees to the left. Then, pull it straight for easy releasing.

Dimensions of mounting holes

For your reference, the dimensions of receptacle mounting holes are given below for different shell sizes for the nut-tightening type and square-flange type. In the case of the nut-tightening type, the dimensions of a

standard connector are the same as those of a waterproof connector. The dimensions of square flanges are those when the flanges are installed on the front surface of a panel. For details, contact our sales or engineering department.

Nut tightening type

Square flange type

Mounting holes, for shell sizes 12, 15

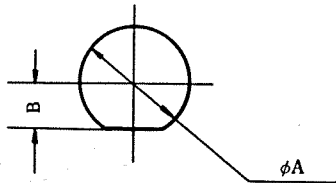

Mounting holes, for shell sizes 21, 24, 31

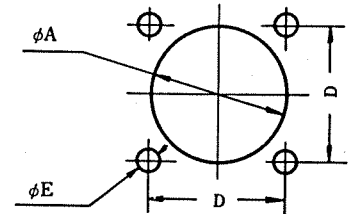
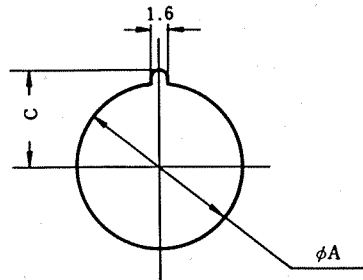



Remark: Use a 0.5 ~ 2 mm thickness panel for all shell sizes.



Mounting method Shell size Locking mechanism Sign	Nut tightening					Square flange	
	12	15		21	24	31	12
	BRD·WBR	QRD	TRH·TRD·WTR	TR·WTR			BRB
φA	14.1	17.1	17.1	22.1	26.1	32.1	14.5
B	6.1	7.6	7.6	—	—	—	—
C	—	—	—	13.3	14.6	18.3	—
D	—	—	—	—	—	—	16
φE	—	—	—	—	—	—	2.9

RM Series contact arrangement

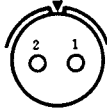
Shell size						
12						
Contact arrangement number	2	3	4	5	6	7
Withstanding voltage	AC1800V for a minute	AC1500V for a minute	AC1500V for a minute	AC1000V for a minute	AC1000V for a minute	AC1000V for a minute
Current rating	5A	5A	5A	5A	5A	5A
Insulation resistance	1000MΩ or more	1000MΩ or more	1000MΩ or more	1000MΩ or more	1000MΩ or more	1000MΩ or more
Contact resistance	4mΩ or less	4mΩ or less	4mΩ or less	4mΩ or less	4mΩ or less	4mΩ or less
Inside diameter of solder pot	φ1.1	φ1.1	φ1.1	φ1.1	φ1.1	φ1.1

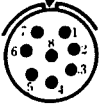
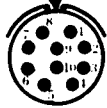
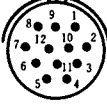
Contact arrangement

Shell size					
15					
Contact arrangement number	2	4	8	10	12
Withstanding voltage	AC1800V for a minute	AC1500V for a minute	AC1500V for a minute	AC1000V for a minute	AC1000V for a minute
Current rating	10A	10A	5A	5A	5A
Insulation resistance	1000MΩ or more	1000MΩ or more	1000MΩ or more	1000MΩ or more	1000MΩ or more
Contact resistance	2mΩ or less	2mΩ or less	4mΩ or less	4mΩ or less	4mΩ or less
Inside diameter of solder pot	φ1.7	φ1.7	φ1.1	φ1.1	φ1.1

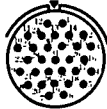
Shell size			Shell size	
21			24	
Contact arrangement number	15	20	Contact arrangement number	31
Withstanding voltage	AC1500V for a minute	AC1000V for a minute	Withstanding voltage	AC1500V for a minute
Current rating	5A	5A	Current rating	5A
Insulation resistance	1000MΩ or more	1000MΩ or more	Insulation resistance	1000MΩ or more
Contact resistance	4mΩ or less	4mΩ or less	Contact resistance	4mΩ or less
Inside diameter of solder pot	φ1.1	φ1.1	Inside diameter of solder pot	φ1.1

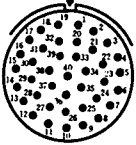
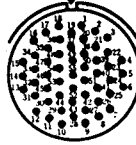
Shell size		
31		
Contact arrangement number	40	55
Withstanding voltage	AC1800V for a minute	AC1500V for a minute
Current rating	5A	5A
Insulation resistance	1000MΩ or more	1000MΩ or more
Contact resistance	4mΩ or less	4mΩ or less
Inside diameter of solder pot	φ1.1	φ1.1

Remarks:

1. Figures show contact arrangements viewed from the fitting side of socket inserts (connecting side of pin inserts).
2. Withstanding voltage is shown in test voltage. In ordinary case, use connectors at about 1/3 of test voltage.
3. Insulator resistance is a value measured at DC 500V.
4. Contact resistance is a value measured at DC 1A.